

The HC-49USSX is the low profile (2.3 mm Max.) resistance weld type Thru Hole quartz crystal.

HC-49USSX QUARTZ CRYSTAL

Request a Sample

HC-49USSX QUARTZ CRYSTAL



- Cost Effective
- Low Profile
- PB Free/RoHS Compliant
- MSL 1

OPERATING CONDITIONS / ELECTRICAL CHARACTERISTICS

PARAMETERS	CONDITIONS	HC-49USSX			UNITS
		MIN	TYP	MAX	
Frequency	Fo	3.570		50.000	MHz
Frequency Tolerance*	@ +25°C			± 30	ppm
Frequency Stability*	-10 ~ +70°C			± 50	ppm
Shunt Capacitance	Co			5	pF
Load Capacitance	Specify in P/N	10	20	Series	pF
Drive Level	DL			500	μW
Operating Temperature*	Topr	-10		+70	°C
Storage Temperature	Tstg	-55		+125	°C
Aging (First Year)	@ +25°C ±3°C			±5	ppm

DIMENSIONS (mm)

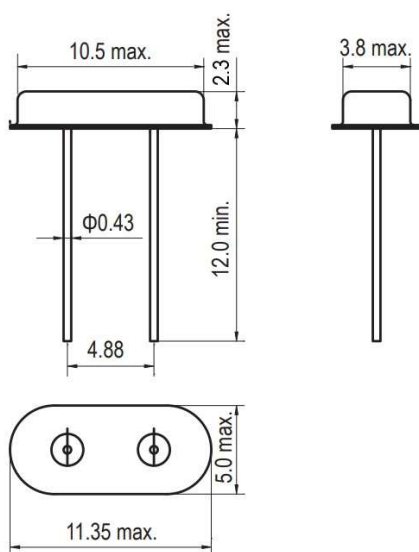

Figure 1) Side, End and Bottom

Frequency (MHz)	ESR Ω Max.	Mode of Osc.
3.570 ~ 4.999	150	Fundamental
5.000 ~ 5.999	120	Fundamental
6.000 ~ 6.999	100	Fundamental
7.000 ~ 8.999	80	Fundamental
9.000 ~ 12.999	60	Fundamental
13.000 ~ 19.999	50	Fundamental
20.000 ~ 30.000	40	Fundamental
26.999 ~ 39.999	100	3 rd Overtone
40.000 ~ 50.000	80	3 rd Overtone

PART NUMBERING GUIDE: Example ECS-200-20-4VX

ECS - FREQUENCY ABBREVIATION	LOAD CAPACITANCE	PACKAGE	AVAILABLE OPTIONS			PACKAGING	
			Tolerance	Stability	Temp Range		
ECS	200 = 20.000 MHz See P/N Guide	20 = 20 pF S = Series	4VX = 2.3 mm	Blank = Std A = ± 25 ppm J = ± 20 ppm R = ± 15 ppm C = ± 10 ppm	Blank = Std D = ± 100 ppm E = ± 50 ppm G = ± 30 ppm H = ± 25 ppm T = ± 20 ppm † W = ± 15 ppm † K = ± 10 ppm †	Blank = Std L = -10 ~ +70°C M = -20 ~ +70°C Y = -30 ~ +85°C N = -40 ~ +85°C P = -40 ~ +105°C S = -40 ~ +125°C U = -55 ~ +125°C	Bulk

* Specify available options in P/N.

† Contact ECS for availability over extended temp range.

Rev.2023

SOLDER PROFILE
Peak solder Temp +260°C Max 10 sec Max.
2 Cycles Max.
MSL 1, Lead Finish Sn/Cu Matte

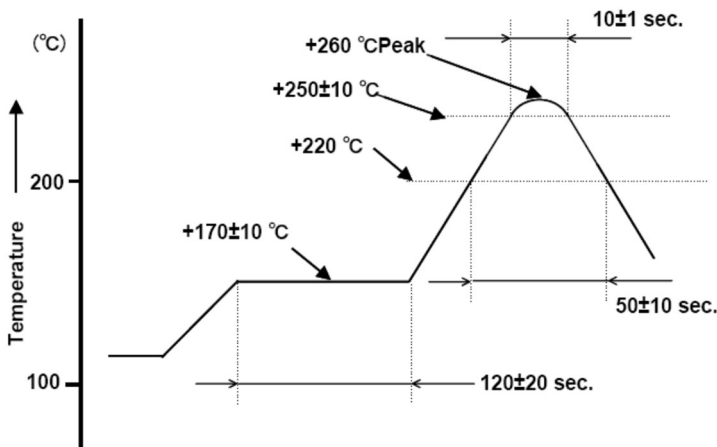

Figure 1) Suggested Solder Profile

DEVELOPED FREQUENCIES	
Abbreviation	Frequency (MHZ)
035	3.579545
036	3.6864
040	4.000
060	6.000
080	8.000
098.3	9.8304
100	10.000
110.5	11.0592
120	12.000
122.8	12.288
143	14.31818
147.4	14.7456
160	16.000
184	18.432
200	20.000
240	24.000
245.7	24.576
250	25.000
270	27.000